

2024 HIND SALE

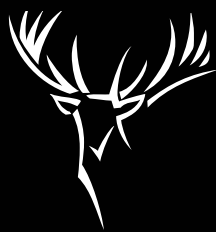

TM

BLACK FOREST PARK

EUROPEAN RED DEER

ALONSO
1,164²/₈" SCI

**WORLD
RECORD**



**ONLINE SALE ON bidr®
THURSDAY, 8 AUGUST AT 7:00PM**

bidr[®] is here.

Trade Livestock Like Never Before

Buy and Sell livestock on bidr[®] in **3 easy steps:**

1

Sign up at www.bidr.co.nz
and add your agency account
under account details

2

Browse auctions
to find livestock you are
interested in buying

3

Login and register for the
real time online auction to
bid for the livestock you
wish to purchase



Real time auctions, bid on livestock from
anywhere.



All livestock listed by livestock agents and
assessed by accredited assessors.



Nationwide Reach. Bringing more buyers
and sellers together, Virtually.



Buy livestock straight from farm resulting in
less stress on animals and positive
environmental benefits.



Full livestock assessment information for buyers
and nationwide reach for sellers.

bidr[®]

Contact your bidr[®]
Representative to sign up
at bidr.co.nz

0800 TO BIDR



fb.com/bidrnz
instagram.com/bidrnz



Dear Friends & Fellow Deer Farmers,

It brings us much pleasure to present to you our 2024 Hind Sale catalogue. The enclosed contains a number of quality breeding hind offerings, a small selection of weaner hinds, embryos, semen and this year a group of rising 3-year-old velveted stags as well.

It has been extremely pleasing for us to see the results of our breeding programs coming through this year, especially with the performance of our new sire Kraken. We were absolutely gutted to lose him at the end of the roar, but we do have hinds incalf and a limited amount of semen in the tank from him. Our stags continue to lift every year, and we were very pleased to see a big gain in not only score but in and length, span and circumferences in our crop of commercial trophy stags this year.

With the success of our embryo program this year, we are able to offer a number of highly specialised embryo lots from the very best bloodlines currently available. This offers discerning buyers a unique opportunity to add to their herds the very best trophy antler genetics currently available.

All of the rising two year old hinds we have on offer were either multi sire mated, or single sired and then mobbed up for the last cycle. The sire team that was used included Kraken, 21556 and 21554.

We have updated our terms and conditions this year so please make sure you check them out on the next page.

We wish you well in your purchases and welcome any pre sale enquiries, either directly or through your preferred deer agent.

Kind regards

Richard, Sarah and the team

Vendor Sale Conditions

1. No animals, embryos or semen sold by Black Forest Park, or their germplasm, any subsequent progeny or germplasm, including the semen and germplasm of that progeny may be supplied to a third party without the written permission of the stud.
2. This condition does not affect normal commercial deer farming or stud farming or the normal sales of semen or embryos as it only applies to entities with the primary function of commercial semen/germplasm activities.
3. It is a condition of sale of any animals, embryos, germplasm or semen sold by Black Forest Park, that the purchaser agrees to include the following clause as a condition of any subsequent sale or gift of any animal, embryo, semen, germplasm or subsequent progeny or germplasm to a third party - "the purchaser acknowledges that it will not supply any animals, embryos, semen or germplasm to any commercial semen/germplasm marketing or sales entity, and will ensure that this clause is inserted as a condition of any sale or gift of any animals, embryos, semen or germplasm."
4. The sale will be conducted by BIDR and Rural Livestock with the conditions of sale as set down by the Stock & Station Agents Association, a copy of which is displayed.
5. The deer are the purchaser's property and risk at the fall of the hammer.
6. Except as otherwise expressly provided in these conditions, no guarantee, representation or warranty of any kind is made or given as to the soundness, condition or quality of any livestock sold in this sale.
7. All Hinds on offer have been vetted in calf and are guaranteed pregnant. Any claims regarding the pregnancy status of the animal must be veterinary verified and raised with the vendor prior to 10 October 2024.
8. Terms are strictly cash unless prior arrangements are made with the auctioneers. Accounts not paid within 14 days of sale shall bear interest, at current rate per annum from the date of sale.
9. The sale is conducted exclusive of GST.
10. Overriding commission is payable to non-participating companies and recognised independent agents introducing and accompanying purchasers to the sale at 4% providing prior arrangements are made with Rural Livestock 24 hours prior to the sale.
11. Intending purchasers are required to register with BIDR prior to the commencement of the sale.

DISCLAIMER

All details and descriptions as to stock listed in the catalogue have been supplied by the vendors although every care has been taken to ensure accuracy in the reproduction of such details and descriptions. Rural Livestock Ltd and their employees or the vendors do not accept any responsibility or liability as to mis-descriptions, errors, omissions, or mis-statements contained therein, including those mis-descriptions, errors, omissions, or mis-statements.

Alonso

SHOWN AT 7YRS

Alonso is an outstanding Harrison son out of a very special Columbia Hind. With very heavy antler, huge tops with good length, he is impressive. His 6 year old head measured an outstanding 934 inches, and won him the accolade of Trophy Antler Champion at the 2022 National Velvet and Hard Antler Competition. He was taken as a trophy at 7 years old, becoming one of the first Stags to break 1000 inches and scored a World Record 1164 ²/₈".

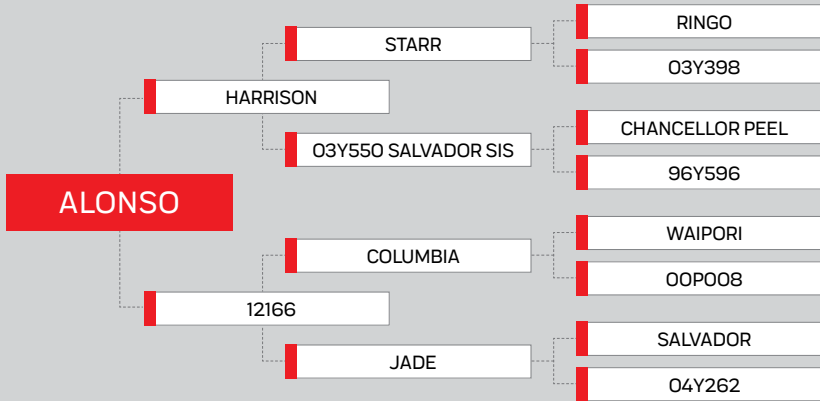

YEAR	WEIGHT (kg)	ANTLER
2		470 IOA
3		576* IOA
4		704 IOA
5	not measured	
6		934 IOA
7		1164 ² / ₈ SCI

REFERENCE SIRE

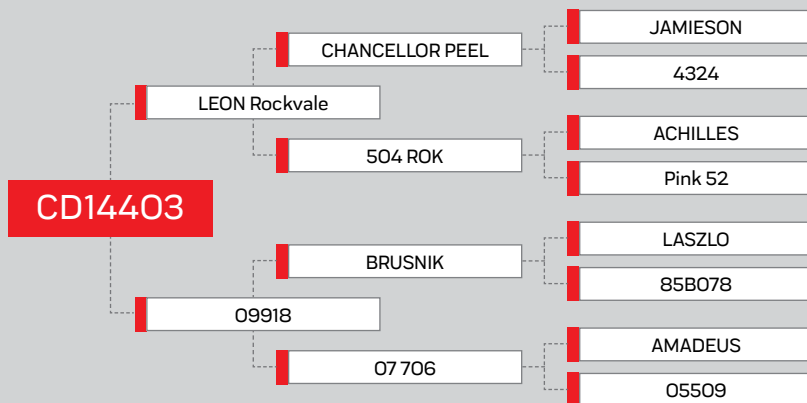

14403

SHOWN AT 6YRS

We purchased 14403 in partnership with Criffel Deer Farm from Crowley Deer in 2017. He breeds very well across our bloodlines adding mass and points to our long wide open style heads, while maintaining our traditional structure. He was third in the 2017 Rising Stars Competition as a 2 year old.

YEAR	WEIGHT (kg)	ANTLER
2		498 6/8*
3		538 4/8*
4		592*
6		742 SCI

**scores exclude burr and span measurement*

Cobra

SHOWN AT 6YRS

Cobra has a huge wide head with clean beam of good circumference and length. He is very like his Sire, Python, and we are looking forward to seeing his progeny come through.

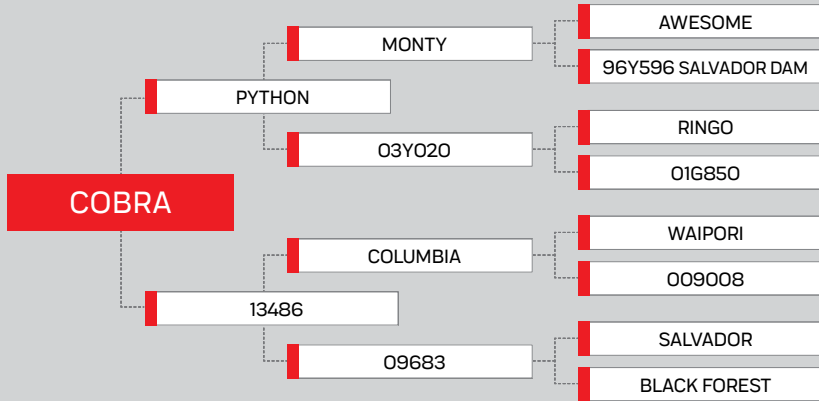

REFERENCE SIRE

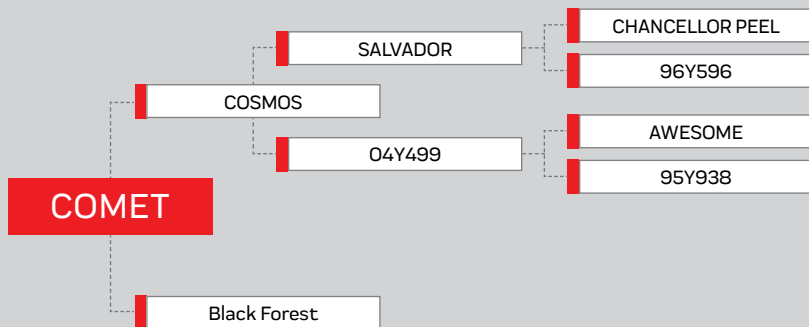

Comet

SHOWN AT 9YRS

Comet has an attractive big open style head with main beams of 42 and 44 inches, and inside span of 38. We haven't used him as extensively as we would have liked, as we've been unable to match his mother. His own performance as he matures and that of the few progeny we've bred are proving this awesome Cosmos son's worth as a Sire.

YEAR	WEIGHT (kg)	ANTLER
2		303 IOA
4		6.4 kg SAP
5		14.2kg HA
6		17.2kg HA
7		501 IOA
8		533 IOA
9		517 SCI

Columbia

SHOWN AT 7YRS

Columbia was a great Stag - high scoring with great length and a lovely open style. We have had many high performing sons and daughters from him.

YEAR	WEIGHT (kg)	ANTLER
7mth	89	
14mth	140	
3		383 IOA
4		484 IOA
6		550 IOA
7		640 IOA
8		655 IOA

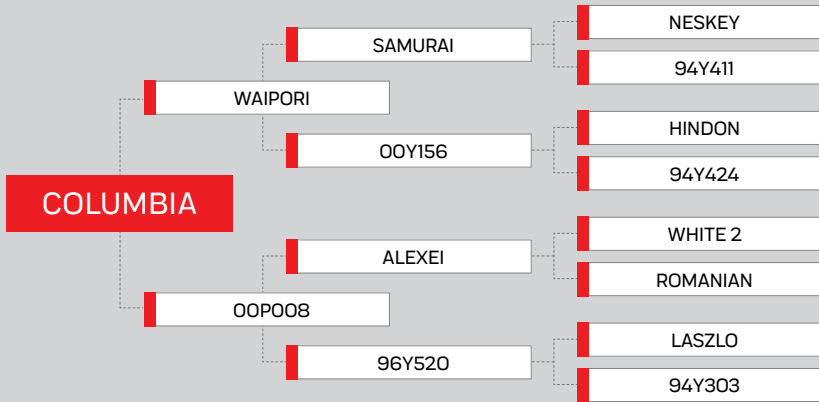

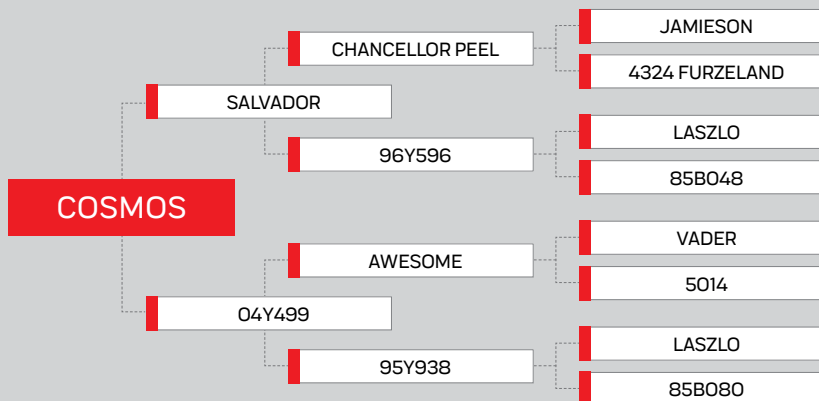

Cosmos

SHOWN AT 6YRS

Cosmos was a very unique Stag with his massive spread and a heavy beam that's clean and has correct placement. He was huge and leaving progeny with good velvet as well as trophy potential. Salvador over Awesome over a Cobalt sister – breeding just what the NZ Trophy Industry requires to stay ahead.

YEAR	WEIGHT (kg)	ANTLER
3		423 IOA
4		475 IOA
5		501 IOA
6		551 IOA
7		491 IOA

Dimitri

4YR OLD VELVET HEAD SHOWN

Dimitri's 4 year old velvet head weighed 9.5kg, and was placed second in the 4 year old section in the National Velvet competition in 2018. With correct placement and only very small snags to fault him, his head is clean and very attractive. Unfortunately now deceased, but we are pleased to watch his young progeny go on to out-perform him. We have a limited amount of Semen available from Dimitri.

YEAR	WEIGHT (kg)	VELVET
3		10 OGI
4		9.5 SAP

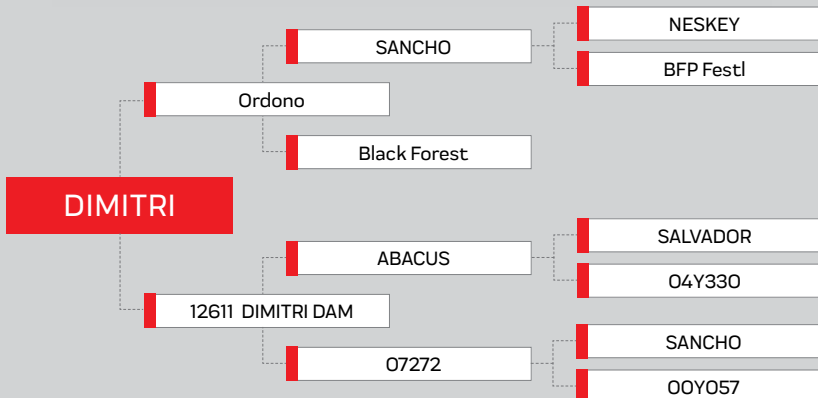

REFERENCE SIRE

Enzo

SHOWN AT 4YRS

The Apex Waipori combination has bred us many great Stags and Enzo is one of the best. We also have another Sire bred by his mother, so he is from a strong pedigree and will pass it on.

YEAR	WEIGHT (kg)	ANTLER
2		328 IOA
3		433 IOA
4		606 IOA

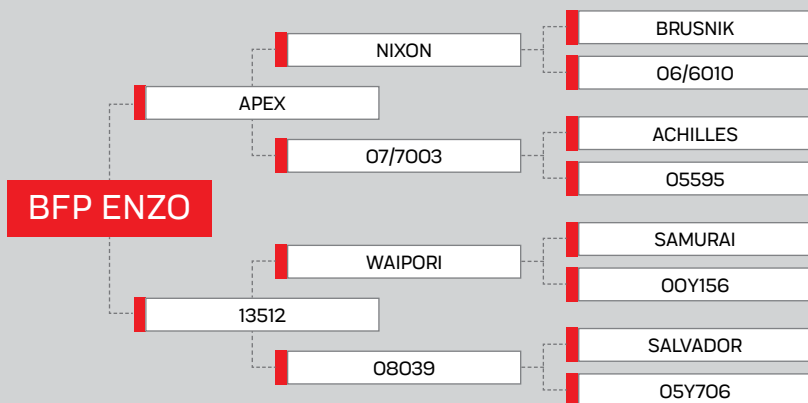

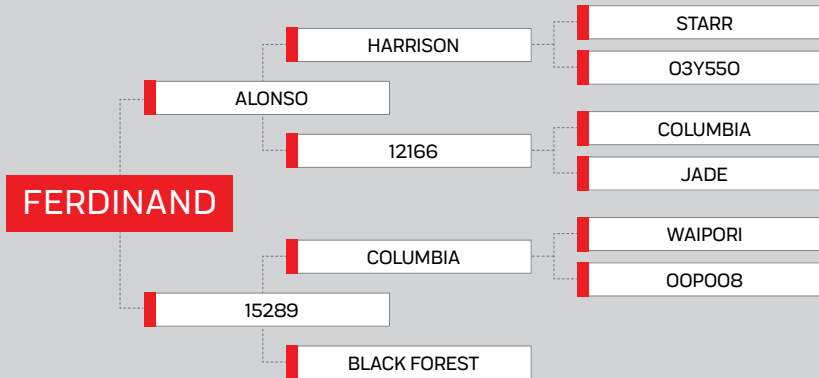

YEAR	WEIGHT (kg)	ANTLER
2		400 IOA
3		618 IOA
4		687 4/8 IOA

Ferdinand

SHOWN AT 5YRS

Owned in partnership with John Scurr. An amazing Alonso son who at 3 years has surpassed his Sire's performance for that age. With massive multi pointed antlers set with an attractive wide style, he has a very heavy beam as well. He carries this huge head very well.

REFERENCE SIRE

Gonzalo

SHOWN AT 5YRS

Another of our new Sires, Gonzalo is an Alonso son from a Starkey daughter out of a Waipori over Salvador Hind. As a 3yr old he was almost a carbon copy of Starkey with bigger circumferences.

YEAR	WEIGHT (kg)	ANTLER
2		304 IOA
3		427 IOA
4		445 IOA
5		479 IOA

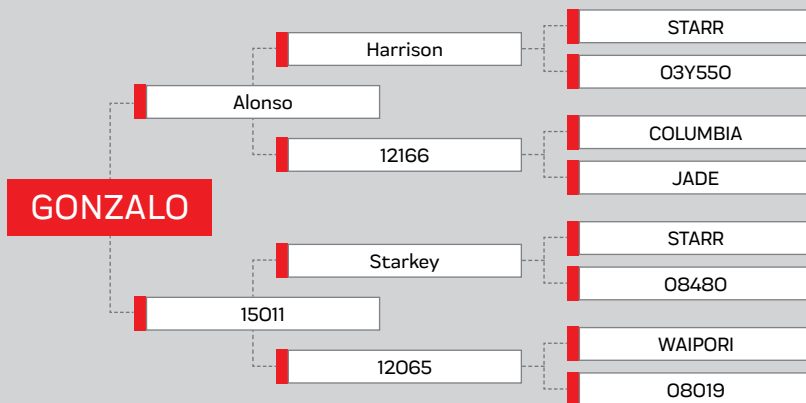

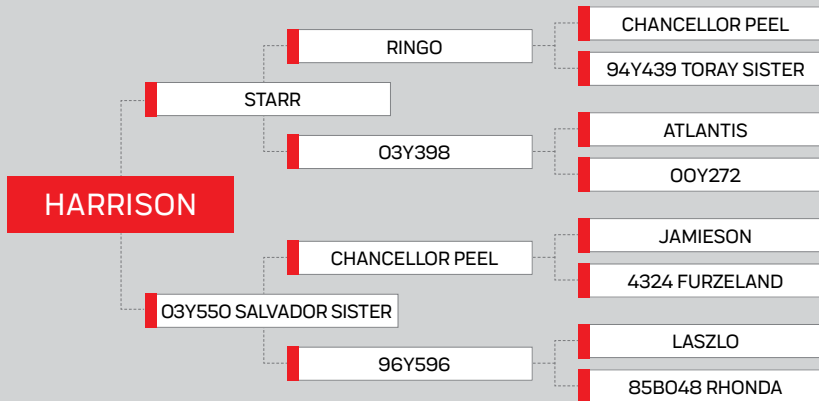

Harrison

SHOWN AT 5YRS

Outstanding son of Starr from a Salvador sister, he has a strong pedigree behind him and is impressive. Unfortunately damage to his left pedicle has compromised his own antler performance, but his value as Sire is compelling, and with sons like Alonso he sure is passing it on.

REFERENCE SIRE

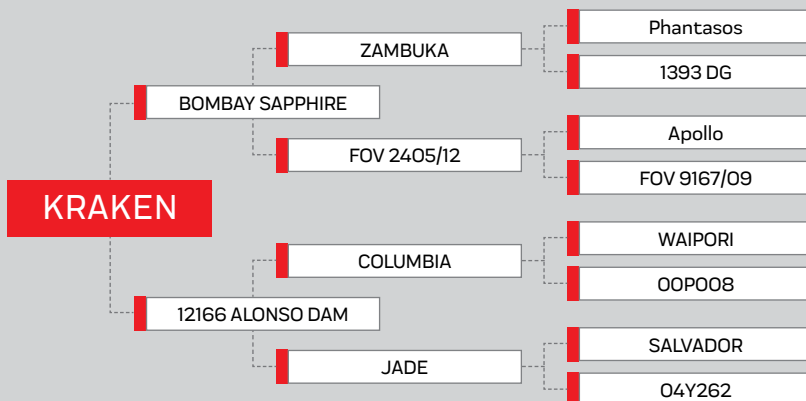

Kraken

SHOWN AT 2YRS

Outstanding breeding and performance from our newest master Sire Kraken, a Sapphire son out of the mother of Alonso. He was 616 inches at 2 (including burrs and span), and a big bodied Stag which gave him the carrying capacity for the massive head he produced. Unfortunately we lost Kraken at the end of the roar and we have only a small amount of Semen in the tank.

YEAR	WEIGHT (kg)	ANTLER
2	193	616 IOA

Owhiro

6YR OLD HEAD SHOWN

Owhiro has a long, wide, heavy and attractive head. His 6 year head was 621 IOA with 45 and 41 inch long main beams, 8 to 9 inch circumferences, 32 inch inside span and 35 points.

YEAR	WEIGHT (kg)	ANTLER
2		354 IOA
5		524 IOA
6		621 IOA

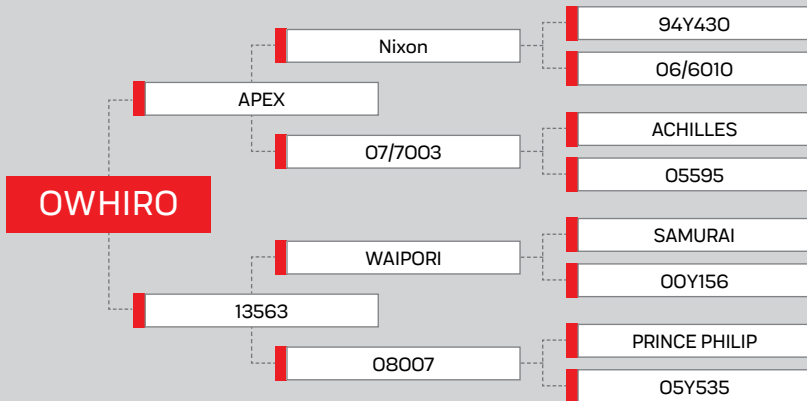

REFERENCE SIRE

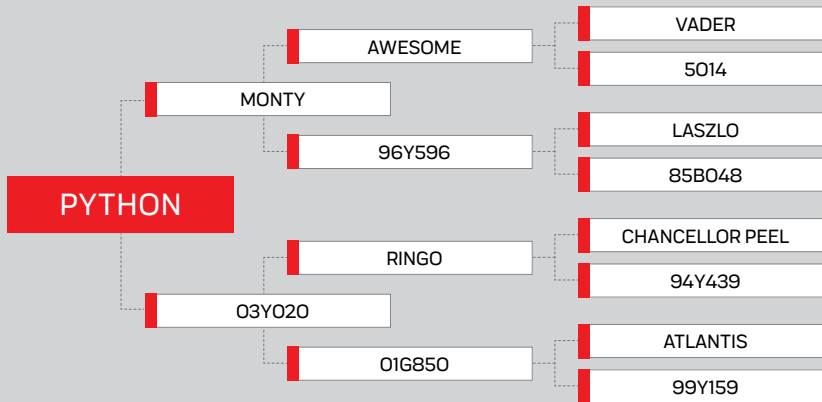

YEAR	WEIGHT (kg)	ANTLER
3		320 IOA
6		452 IOA
9		502 SCI

Python

SHOWN AT 9YRS

We had Python in our Sire group for a number of years. Unfortunately now deceased, he had a very attractive head that was heavy in the beam, clean with good length and spread. A true multipurpose Sire for Velvet and trophy.

Starkey

SHOWN AT 7YRS

Outstanding Starr son almost identical to his Sire for age. With his symmetry, width, length and kickers he has a great style and presence about him. A strong pedigree for big wide outstanding trophy and velvet Stags.

YEAR	WEIGHT (kg)	ANTLER
3		372 IOA
5		476 IOA
6		508 IOA
7		550 IOA

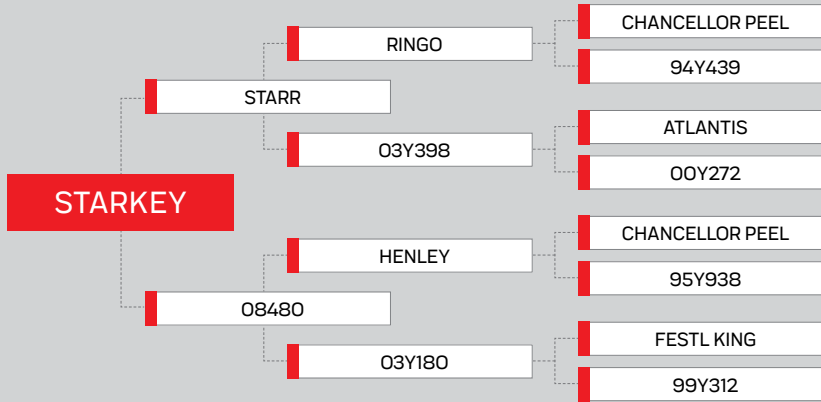

REFERENCE SIRE

Starr

SHOWN AT 7YRS

Lovely Stag with wide head and long tidy tynes.
Starr is by Ringo and has easily surpassed his famous Sire at maturity, with a huge head.

YEAR	WEIGHT (kg)	ANTLER
3		397 IOA
4		453 IOA
5		475 IOA
6		525 IOA
7		566 IOA
8		585 IOA

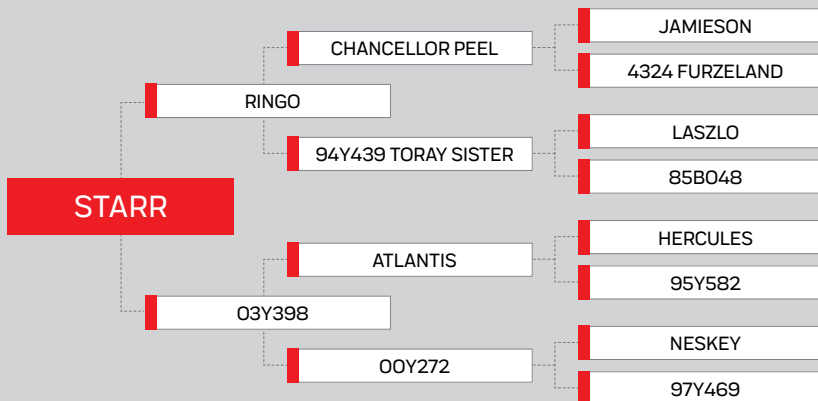

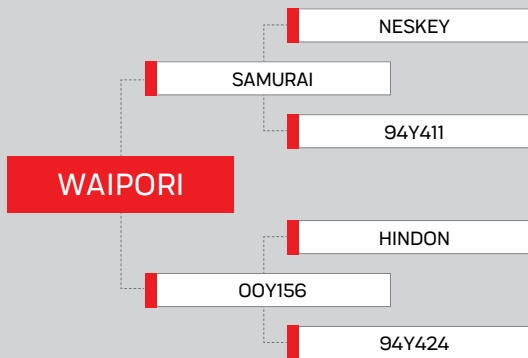

Waipori

SHOWN AT 7YRS

Waipori was the heaviest antlered red deer in the Industry of his time, cutting 23.4 HA as a 7yr old and 547 IOA amazing Stag. Again one of our key background Sires.

YEAR	WEIGHT (kg)	VELVET (kg)
6mth	98	-
12mth	139	-
2	231	-
3	289	11.9 H/A
6	-	500 IOA 19.4kg
7	-	547 IOA 23.4kg
Est. 7	-	16kg SA2

REFERENCE SIRE

YEAR	WEIGHT (kg)	VELVET kg
1	134	4.2
2		4.3 SAT
6		416 IOA

17430

430 by Joseph has been in our Sire team since he was a spiker, we've been very impressed with his tidy style of velvet and good length and width of antler that is extremely dense.

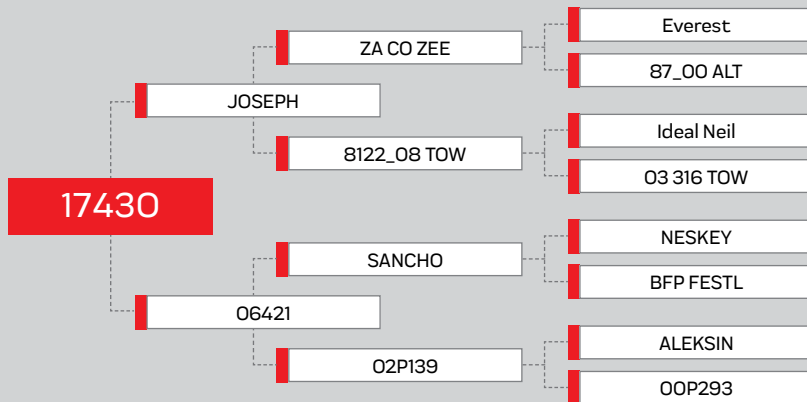

Winnie

YEAR	WEIGHT (kg)	ANTLER
2	184	5.1 SAT
4		8.16 SAT
5		408 IOA

Winnie

Winnie has a long and correct velvet head with great beam, he grows out to an attractive long wide trophy as well.

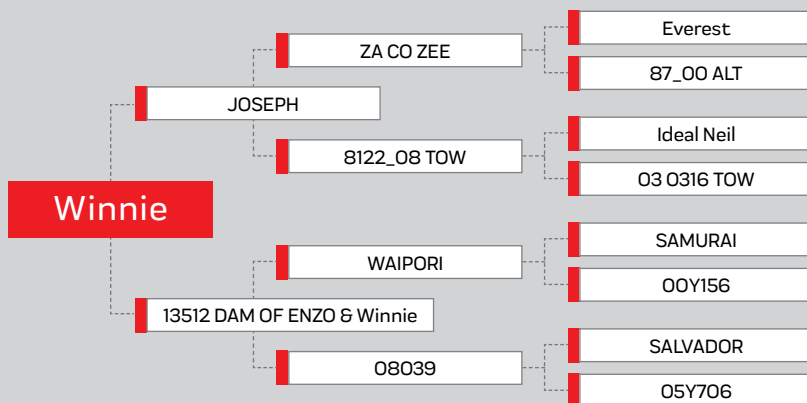

21114

A Cobra son we selected for his attractive style. At 2 years of age he was 350 inches with 31 inch beams and 29 inside.

YEAR	WEIGHT (kg)	ANTLER
2	175	350 IOA

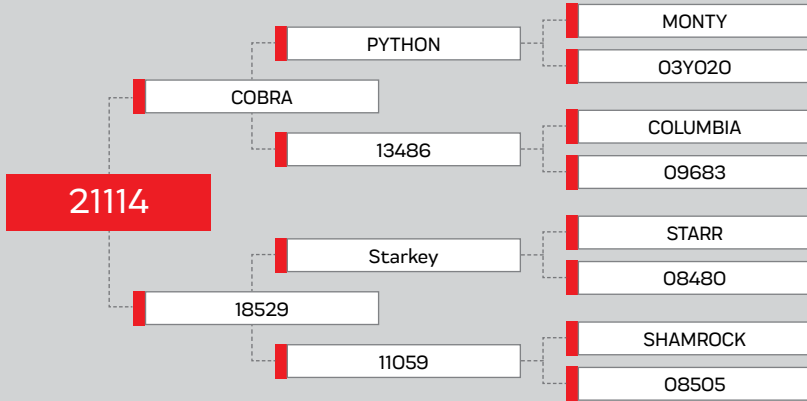

21554

21554

A young Sire with a big future, he was 412 5/8 with 29 points at two and 180 kg.

YEAR	WEIGHT (kg)	ANTLER
2	180	412 IOA

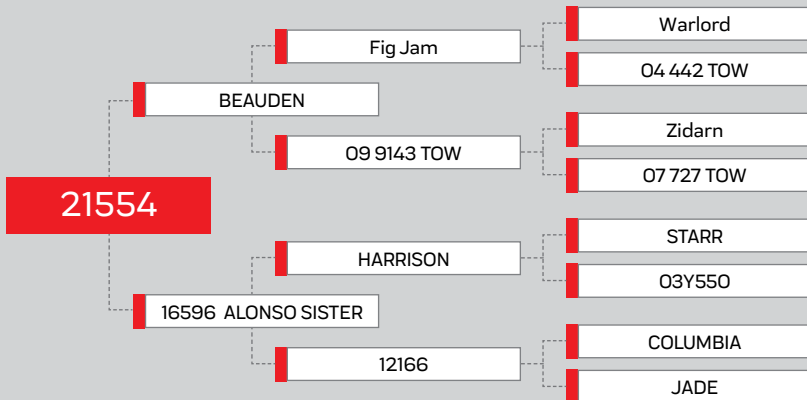

REFERENCE SIRE

10933

This Henley son throws back to the style of his Dams' Sire Randell, producing a nice round clean heavy beam with good length and style.

YEAR	WEIGHT (kg)	ANTLER
3		335 IOA
4	6.9kg	SAT
5	7.9kg	SAT
6	9.8kg	SAP
7		481 IOA
8	9.6kg	SAT
9	12.1kg	SANT
10	15.8kg	SS
11	12.1kg	SAT
12		519 SCI

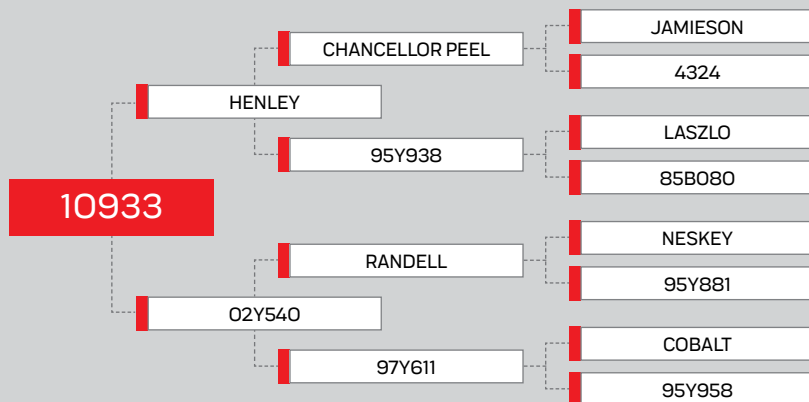

21556

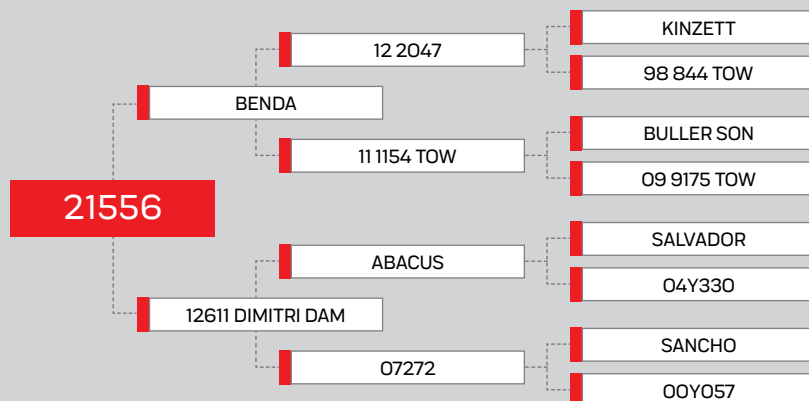

YEAR	WEIGHT (kg)	VELVET (kg)
2	163	6.2 SANT

21556

A new Sire we selected this year with a brilliant pedigree. He cut 6.2kg as a 2 year old

2024 Catalogue Index

Lot	Tag	Age	Sire	Dam	Dam Sire
1	23415	8 Month	STARR	08480	HENLEY
2	23473	8 Month	HARRISON	12166	COLUMBIA
3	23482	8 Month	Alonso	15289	COLUMBIA
4	23499	8 Month	TUSSOCK	13512	WAIPORI
5	17514	Embryo	Tennessee	21549	BOMBAY SAPPHIRE
6	20192	Embryo	KRAKEN	16386	STARR
7	15293	Embryo	BENDA	12611	ABACUS
8	15287	Embryo	PURDEY	08480	HENLEY
9	22535	20 Month	FERDINAND	14027	12509
10	22394	20 Month	Alonso	16196	PYTHON
11	22264	20 Month	Starkey	11708	WAIPORI
12	22260	20 Month	OWHIRO	16633	SALVADOR
13	22032	20 Month	GONZALO	13512	WAIPORI
14	22016	20 Month	GONZALO	13471	WAIPORI
15	18310	5	Alonso	15567	SUMMOR
16	17360	6	RIGBY	12757	AMAZON
17	21286	2	COBRA	18265	Starkey
18	21057	2	Alonso	16206	AMAZON
19	20588	3	COBRA	18612	COMET
20	21465	2	17563	15289	COLUMBIA
21	20294	3	APEX	16586	HARRISON
22	20348	3	Alonso	11707	WAIPORI
23	16209	7	PYTHON	06322	SALVADOR
24	18524	5	CD14403	16087	APEX
25	16454	7	APEX	12520	ODYSSEUS
26	18571	5	CD14403	16206	AMAZON
27	20475	3	JOSEPH	07166	NESKEY
28	19358	4	ABACUS	10591	07788
29	20293	3	10933	10679	INGLEWOOD
30	19242	4	ORDONO	11717	WAIPORI
31	16179	7	ABACUS	12808	SANCHO
32	16156	7	ABACUS	04Y686	SHERWOOD
33	15102	8	RITCHIE	05Y571	AUSTIN
34	14605	9	ATILLA	08588	MONTY
35	Semen Lot	5 Straws	Alonso	Semen	
36	Semen Lot	2 Straws	Kraken	Semen	
37	Semen Lot	10 Straws	Starkey		
38	Semen Lot	10 Straws	Starr		
39	Velvet Stags	Rising 3			

LOT 1

8 Month Hind



BLACK FOREST PARK
EUROPEAN RED DEER

COMMENTS

Full sister to our Legacy master Sire Starkey known for his width and style, she was 60kg on 18 July 2024.

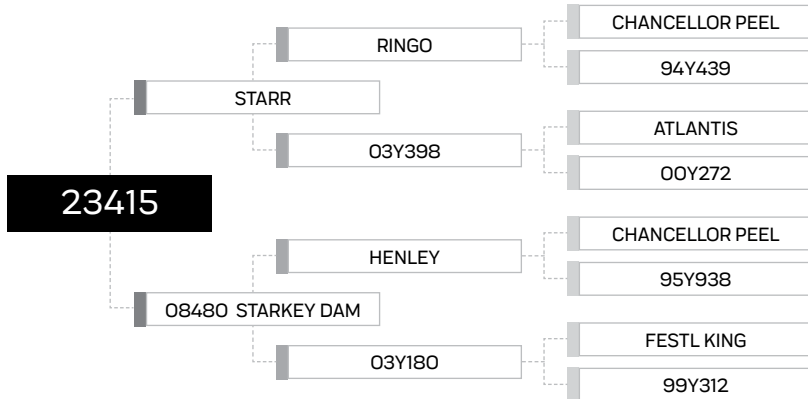

LOT 2

8 Month Hind



BLACK FOREST PARK
EUROPEAN RED DEER

COMMENTS

Full Sister to the SCI world record Stag Alonso she was 70.5kg on 18 July 2024.

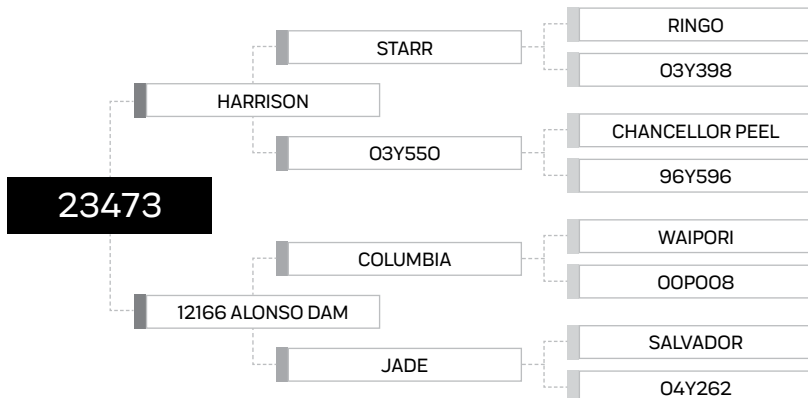

LOT 3

8 Month Hind



BLACK FOREST PARK
EUROPEAN RED DEER

COMMENTS

Full Sister to Ferdinand, she was 67.5kg on 18 July 2024.

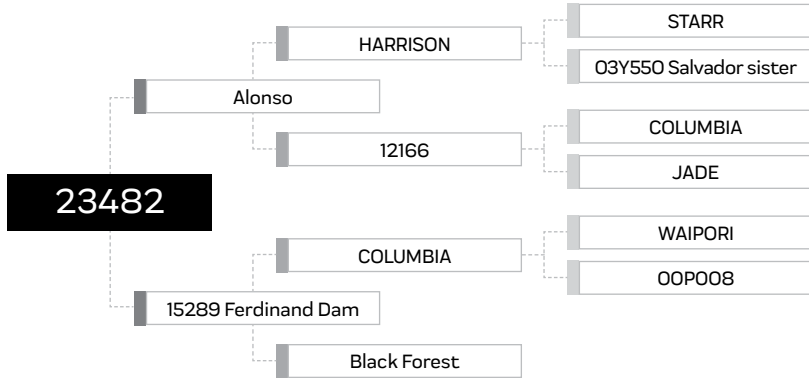

LOT 4

8 Month Hind



BLACK FOREST PARK
EUROPEAN RED DEER

COMMENTS

From the Dam of our Sires Enzo and Winnie, by Tussock who was 785 SCI. She was 75kg on 18 July 2024.

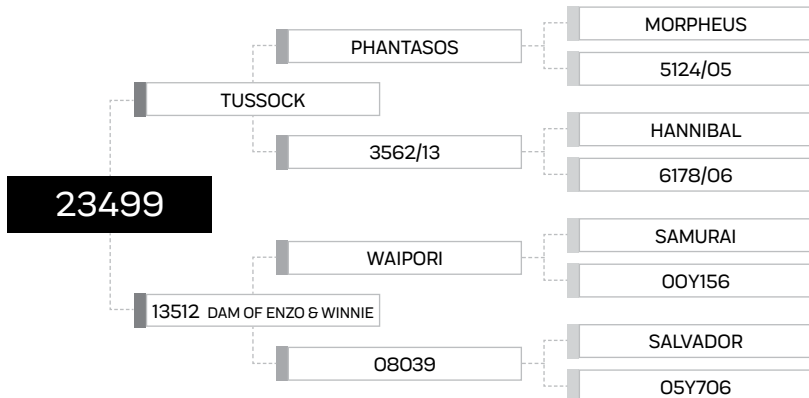

LOT 5

Embryo



BLACK FOREST PARK
EUROPEAN RED DEER

COMMENTS

A very special embryo here, Tennessee from Canes (winner of the Rising Stars 4 yr old section, peoples choice and Supreme Trophy with 1042 inches), over a Kraken Sister.

V.I.C. recip 17514

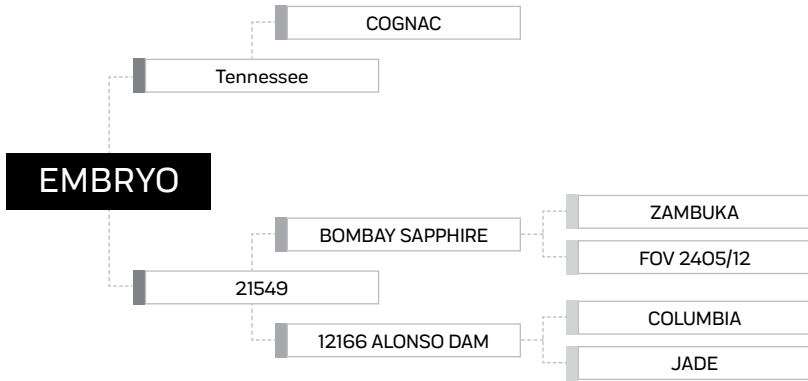

LOT 6

Embryo



BLACK FOREST PARK
EUROPEAN RED DEER

COMMENTS

Another special lot here, product of our 2024 ET program by our new outstanding Sire Kraken (sadly deceased) from the Dam of Lot 2 in our 2024 Sire Sale sold to Daryl Butterick.

V.I.C. recip 20192

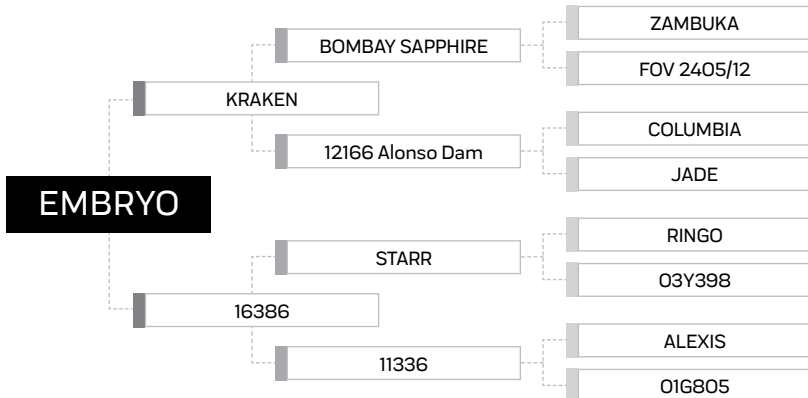

LOT 7

Embryo

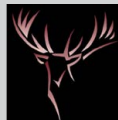

BLACK FOREST PARK
EUROPEAN RED DEER

COMMENTS

Former NZ velvet Champion Benda over the Mother of former NZ Velvet open second place winner Dimitri. This embryo is a full sibling to our new Sire 21556.

V.I.C. recip 15293

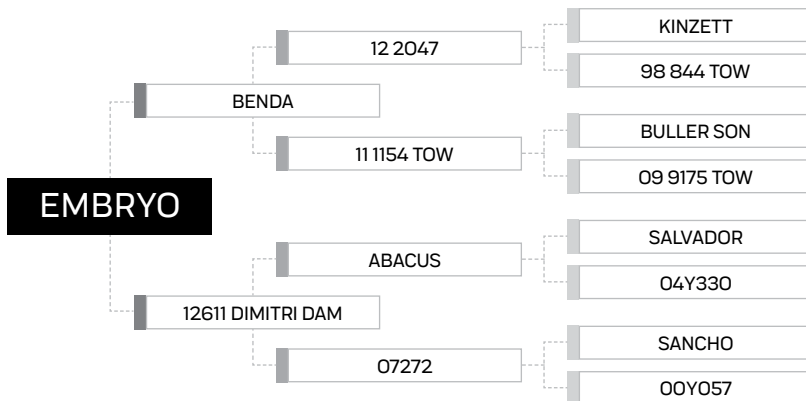

LOT 8

Embryo

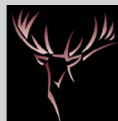

BLACK FOREST PARK
EUROPEAN RED DEER

COMMENTS

Purdey was 930 inches at 6. This embryo Sired by him out of Starkeys Dam contains the right mix for inches and style.

V.I.C. recip 15287

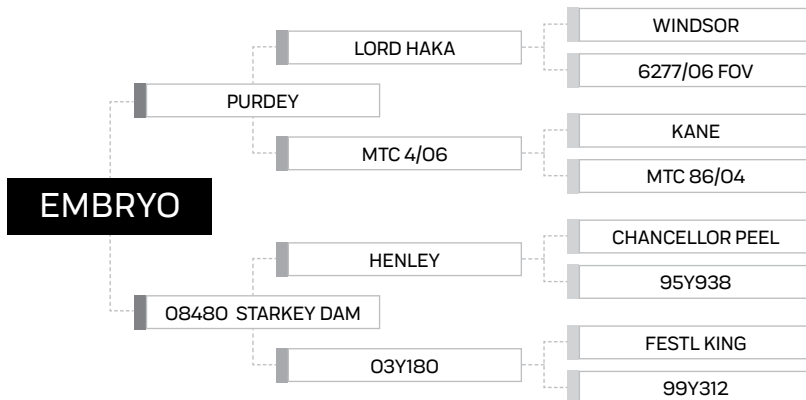

LOT 9

20 Month Hind



BLACK FOREST PARK
EUROPEAN RED DEER

COMMENTS

A Ferdinand daughter from our Dam 14027 who also produced us 19002, a very nice Maple son which was in our Sire team in 2022.

V.I.C. Multi sire mated

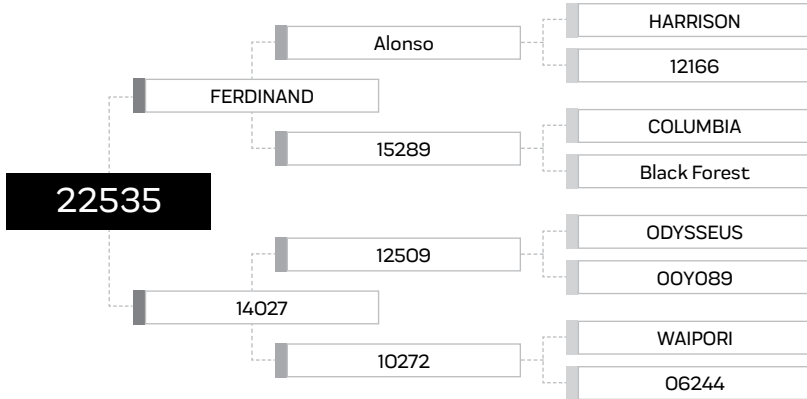

LOT 10

20 Month Hind

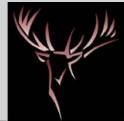

BLACK FOREST PARK
EUROPEAN RED DEER

COMMENTS

With Alonso, Python and Salvador in the mix this young Hind has weight, length and points in her genes.

V.I.C. Multi sire mated

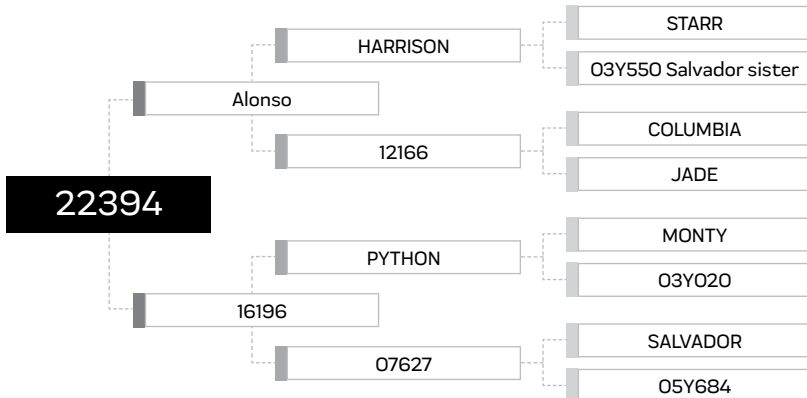

LOT 11

20 Month Hind



BLACK FOREST PARK
EUROPEAN RED DEER

COMMENTS

A Starkey daughter, from a Waipori Hind by Salvador and Sintana over a Brusnik sister.

V.I.C. Multi sire mated

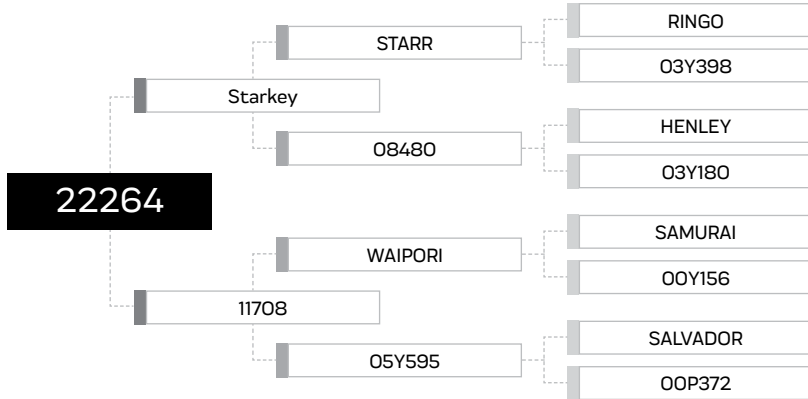

LOT 12

20 Month Hind

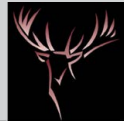

BLACK FOREST PARK
EUROPEAN RED DEER

COMMENTS

The grand Dam of this young Hind is 13511 who is also the Dam of one of our Sires 21493.

V.I.C. Multi sire mated

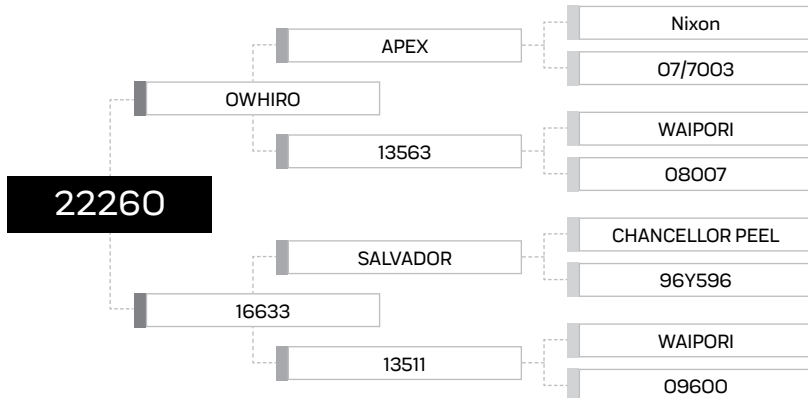

LOT 13

20 Month Hind



BLACK FOREST PARK
EUROPEAN RED DEER

COMMENTS

We used Gonzalo as a backup in 2022 over our ET Hinds. After a very good flush, our donor Hind 13512 got in calf to Gonzalo to give us this daughter as well.

V.I.C. 21114

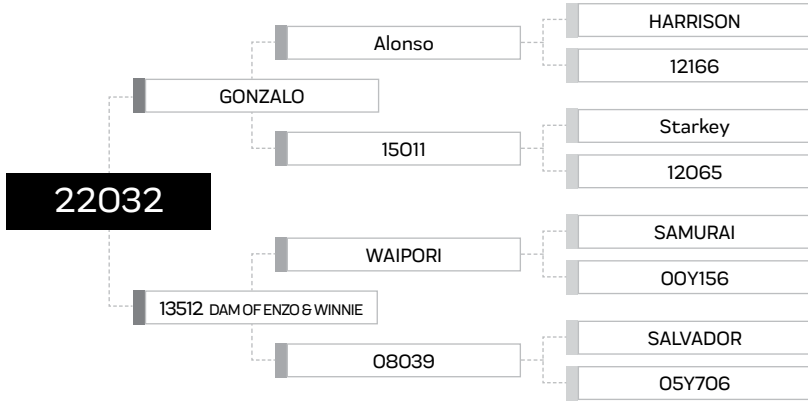

LOT 14

20 Month Hind



BLACK FOREST PARK
EUROPEAN RED DEER

COMMENTS

Dam 13471 is also the Dam of 16593 lot 11 in our 2019 Sale sold for \$20k

V.I.C. 21114

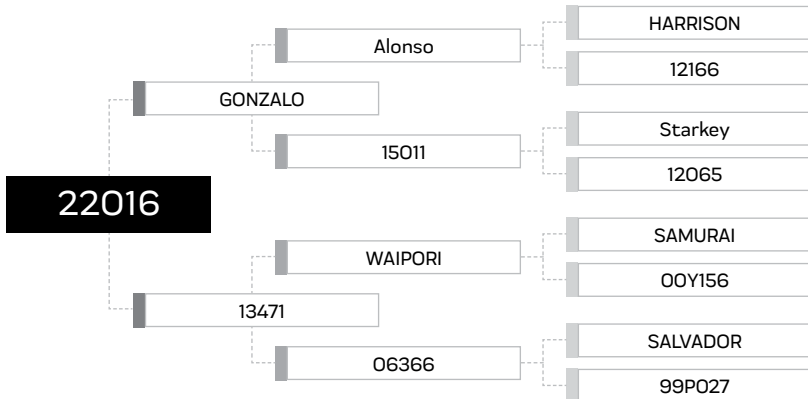

LOT 15

5 Year old Hind



BLACK FOREST PARK
EUROPEAN RED DEER

COMMENTS

Alonso over Summor, Waipori and Salvador. We selected a two year old Cobra son from her this year to go into our elite R3 mob.

V.I.C. OWHIRO

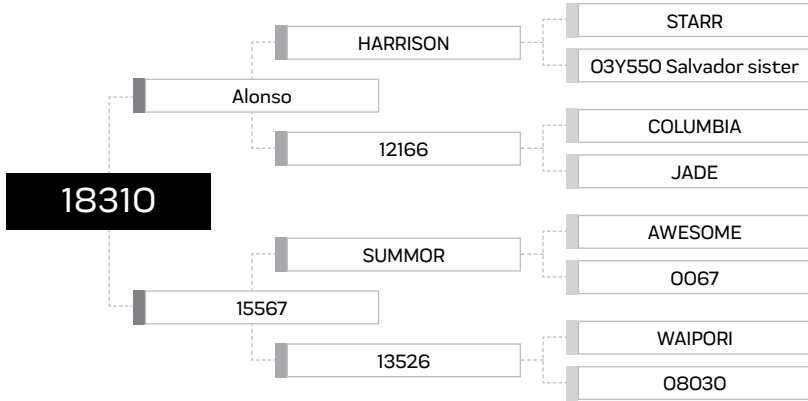

LOT 16

6 Year old Hind



BLACK FOREST PARK
EUROPEAN RED DEER

COMMENTS

Rigby over Amazon, lots of points in this mix.

V.I.C. Gonzalo

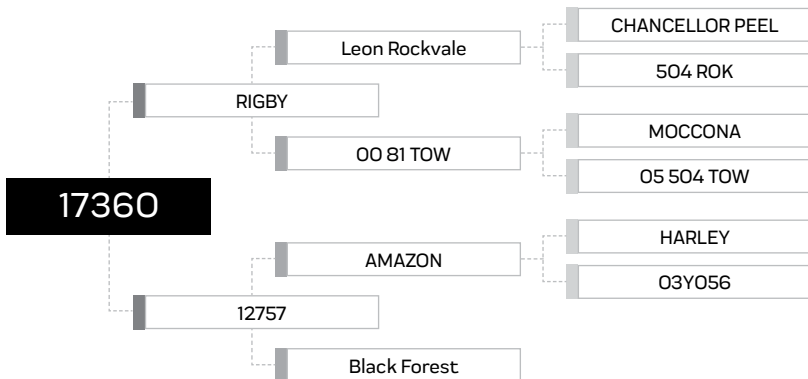

LOT 17

2 Year old Hind

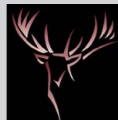

BLACK FOREST PARK
EUROPEAN RED DEER

COMMENTS

A Cobra daughter from a Starkey Hind, her grand Dam gave us lot 1 in our 2019 Sire Sale, sold for \$15k. She is scanned infawn to Enzo.

V.I.C. Enzo

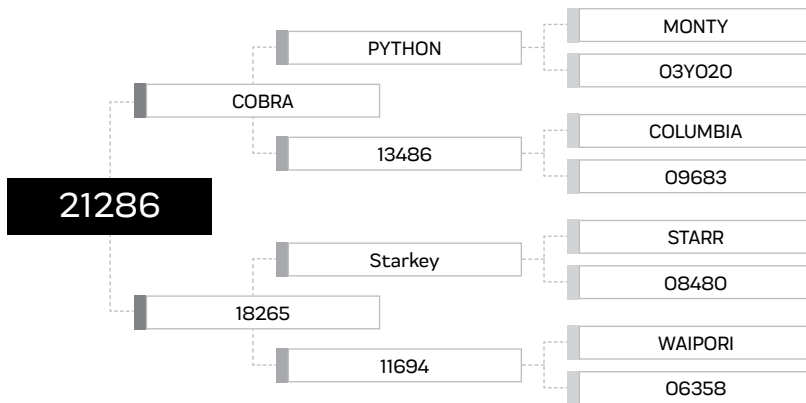

LOT 18

2 Year old Hind

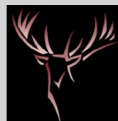

BLACK FOREST PARK
EUROPEAN RED DEER

COMMENTS

This Hind has strong antler influences from our World record Stag Alonso, over Amazon, Sintana, Romany and Nicholai. In calf to Enzo.

V.I.C. Enzo

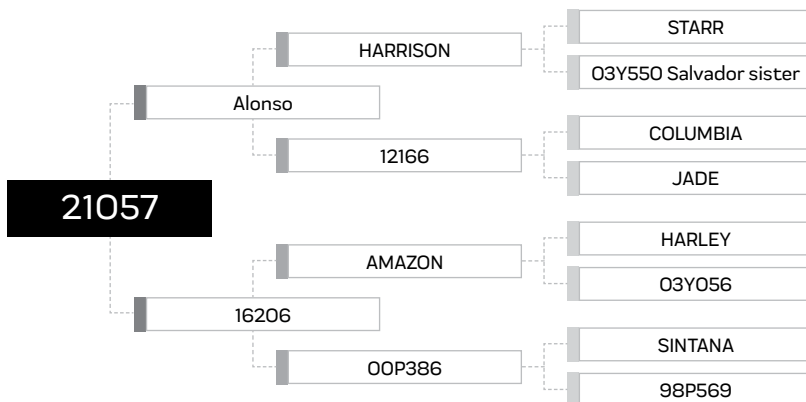

LOT 19

3 Year old Hind

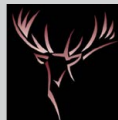

BLACK FOREST PARK
EUROPEAN RED DEER

COMMENTS

What a mix! Cobra, Comet, Columbia and Chancellor Peel and incalf to Ferdinand.

V.I.C. Ferdinand

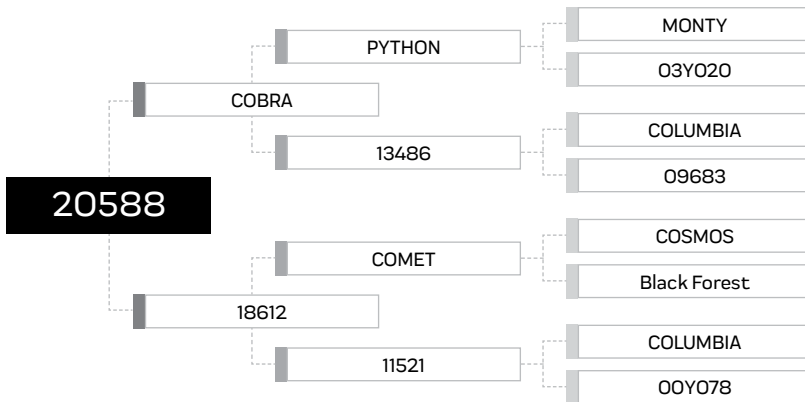

LOT 20

2 Year old Hind

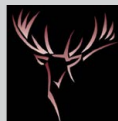

BLACK FOREST PARK
EUROPEAN RED DEER

COMMENTS

This Hind is out of Ferdinands' Dam, sired by a Harrison son we used for antler and body mass. She is incalf to our new Sire 493 who is a Beauden son out of a Waipori daughter from Dominics' Dam.

V.I.C. 21493

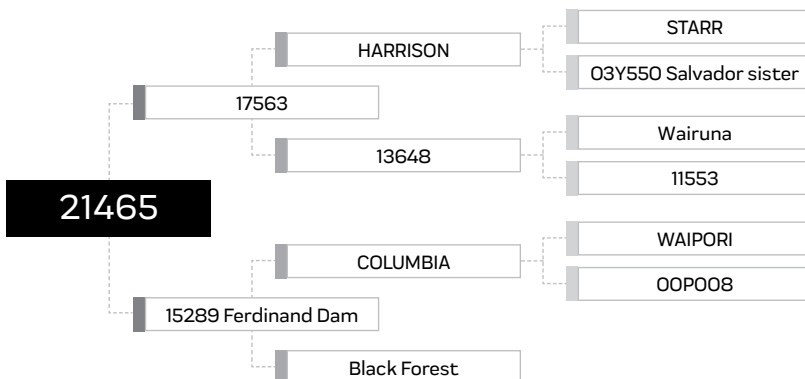

LOT 21

3 Year old Hind



BLACK FOREST PARK
EUROPEAN RED DEER

COMMENTS

Apex was a very effective outcross for us, this breeding giving us many Sires, industry Sires and replacements. This daughter goes back to Harrison, Chancellor Peel and Laszlo. She is incalf to Comet.

V.I.C. Comet

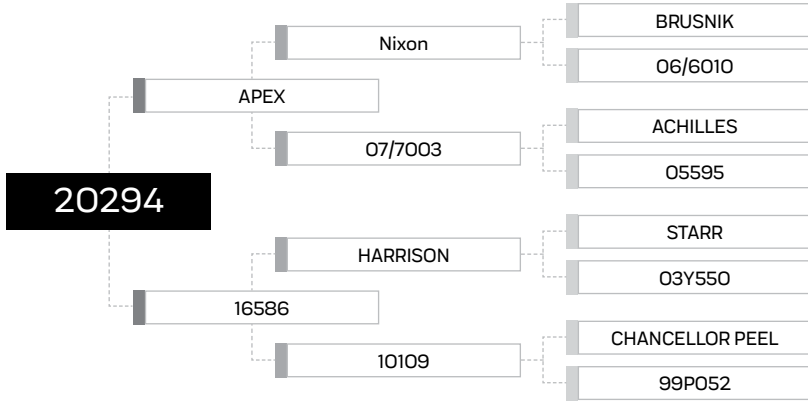

LOT 22

3 Year old Hind



BLACK FOREST PARK
EUROPEAN RED DEER

COMMENTS

A 3 year old Alonso daughter from a Waipori Hind. Her Grand Dam had a Harrison son that was lot 6 in our 2020 Sale, plus two Waipori sons in our 2011 and 2012 Sales.

V.I.C. Comet

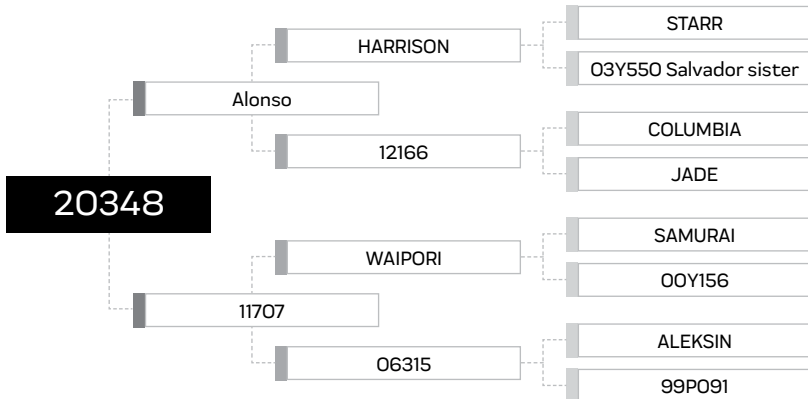

LOT 23

7 Year old Hind



BLACK FOREST PARK
EUROPEAN RED DEER

COMMENTS

This Python daughter is from Dam 06322, she was bred by Salvador over our legacy Sire Harleys' Dam. 06322 Also had a Kutana son in our 2013 Sale.

V.I.C. Comet

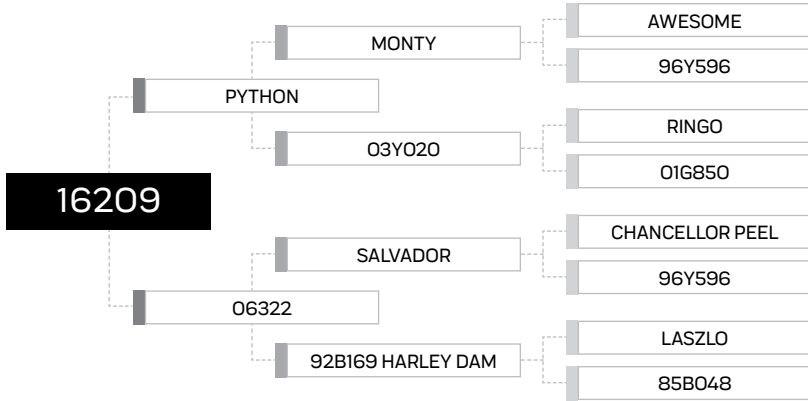

LOT 24

5 Year old Hind



BLACK FOREST PARK
EUROPEAN RED DEER

COMMENTS

A daughter of 14403, her Dam 16087 had an Alonso son that was lot 8 in our 2023 Sale, and was lot 12 herself in our 2023 Hind Sale. We selected a two year old Alonso son from her this year into our elite R 3 mob.

V.I.C. Comet

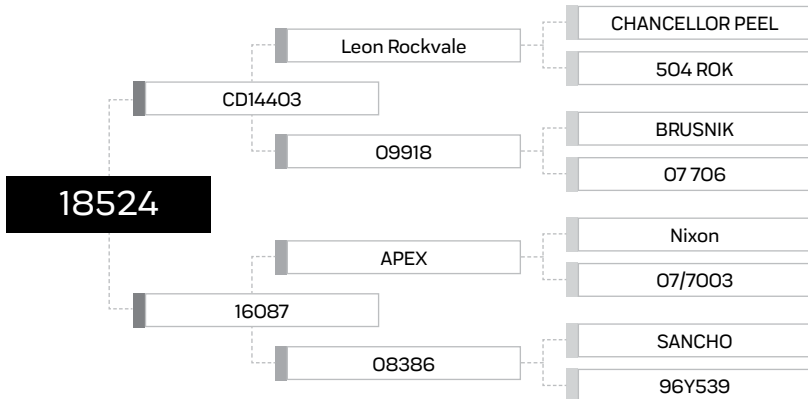

LOT 25

7 Year old Hind



BLACK FOREST PARK
EUROPEAN RED DEER

COMMENTS

Apex, Odysseus and Chancellor Peel over a Toray sister by Laszlo. She is incalf to Gonzalo.

V.I.C. Gonzalo

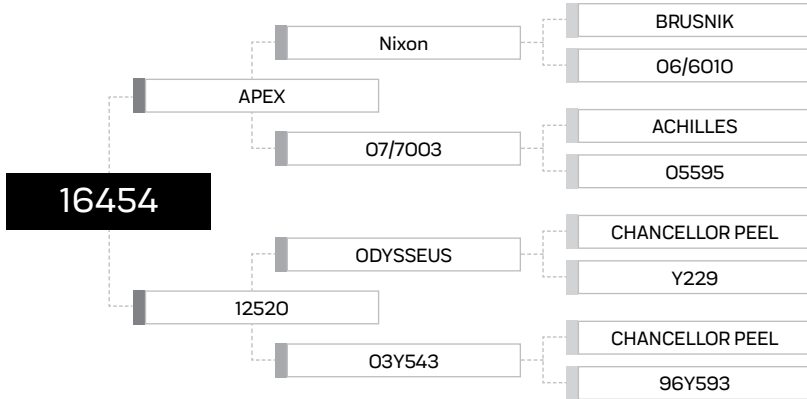

LOT 26

5 Year old Hind

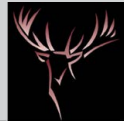

BLACK FOREST PARK
EUROPEAN RED DEER

COMMENTS

We tactically bred with 14403 to add mass and points; across Amazon to create this Hind, she should breed a very good trophy antler animal.

V.I.C. Ferdinand

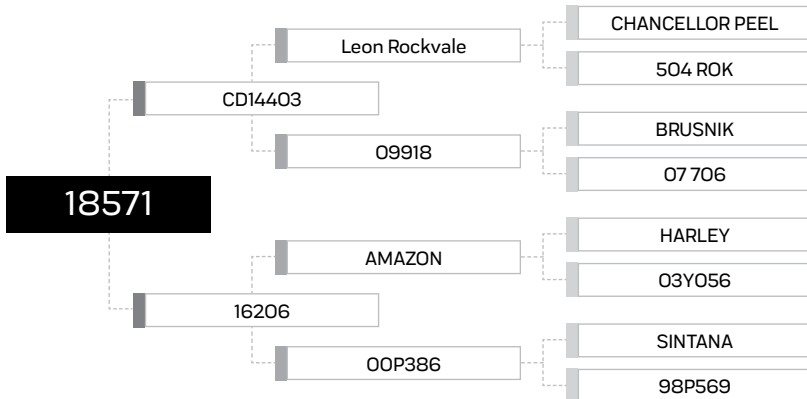

LOT 27 3 Year old Hind

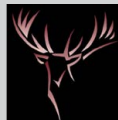

BLACK FOREST PARK
EUROPEAN RED DEER

COMMENTS

Nice velvet breeding in this Hind and incalf to Matrix. A full sister to this Hind is the Dam of our new Sire 21441 (by Dimtri who cut a super tidy 5.1kg at 2).

V.I.C. Matrix

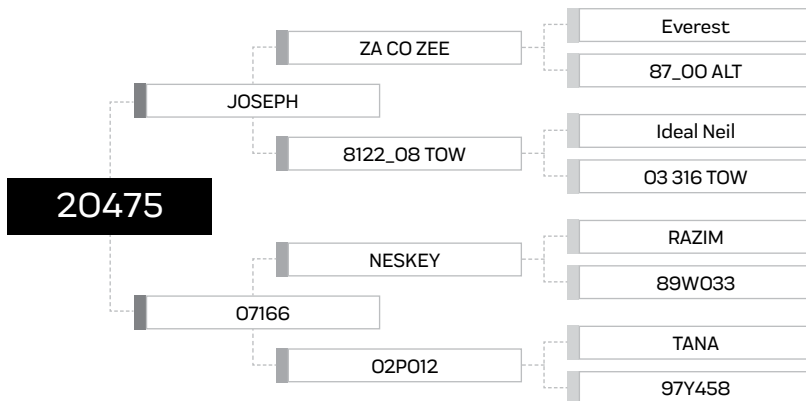

LOT 28 4 Year old Hind

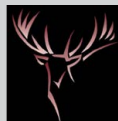

BLACK FOREST PARK
EUROPEAN RED DEER

COMMENTS

Abacus over 788 (who cut 9.6 SAP at 6 and bred long typical heads) over the Dam of our Stud Sire 17430. She is incalf to Winnie.

V.I.C. Winnie

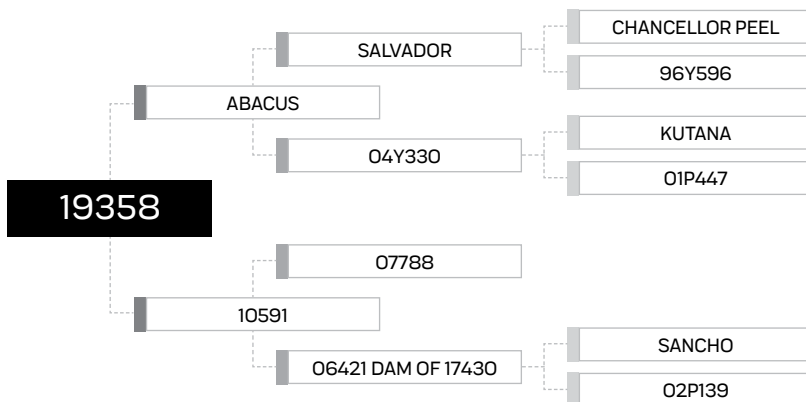

LOT 29

3 Year old Hind



BLACK FOREST PARK
EUROPEAN RED DEER

COMMENTS

933 over Inglewood, Berwick and Sancho. Tidy velvet genes in this Hind.

V.I.C. Winnie

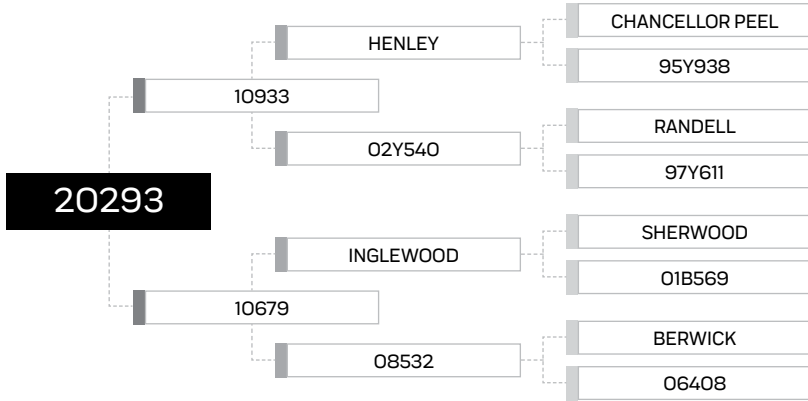

LOT 30

4 Year old Hind



BLACK FOREST PARK
EUROPEAN RED DEER

COMMENTS

Ordoneo over Waipori, Kutana, Jamieson and Laszlo. Incalf to 430.

V.I.C. 17430

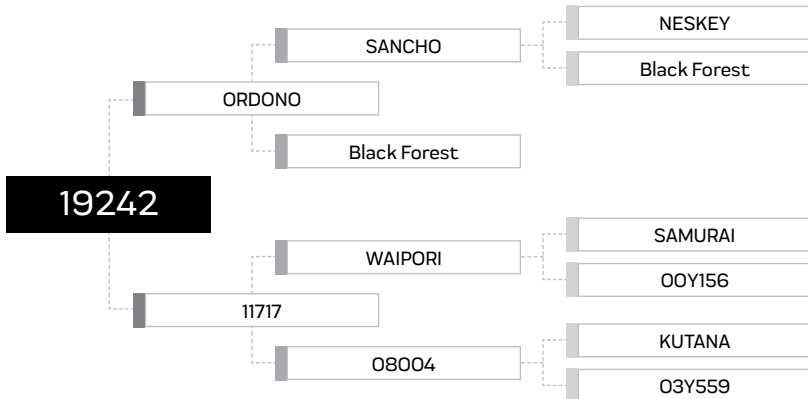

LOT 31

7 Year old Hind



BLACK FOREST PARK
EUROPEAN RED DEER

COMMENTS

Targeted breeding in this Hind for tidy velvet. She is pregant by AI to 18977 which we own in partnership with Puketapu Park.

V.I.C. Brck 18977

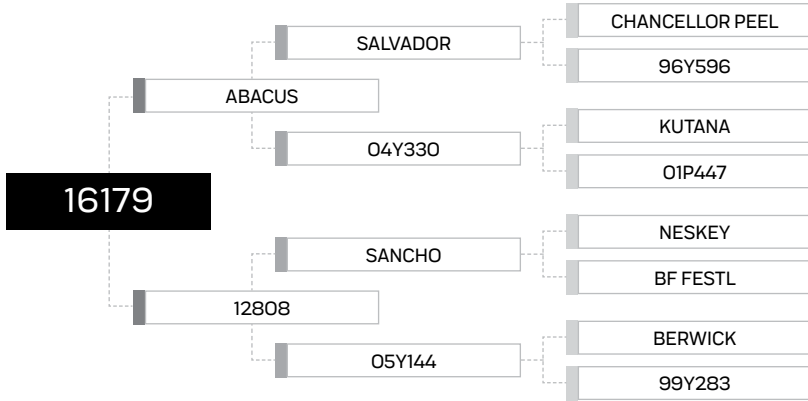

LOT 32

7 Year old Hind



BLACK FOREST PARK
EUROPEAN RED DEER

COMMENTS

Abacus over a pure Warnham Dam 04686.

V.I.C. 17430

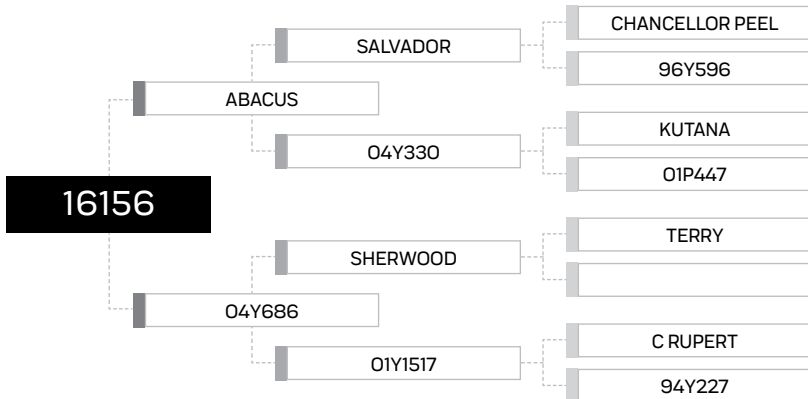

LOT 33

8 Year old Hind



BLACK FOREST PARK
EUROPEAN RED DEER

COMMENTS

15012 has bred us some good ones including the Alonso son who was lot 5 in our 2022 Sale. Her Dam had lot 3 in the 2017 Sire Sale.

V.I.C. Alonso

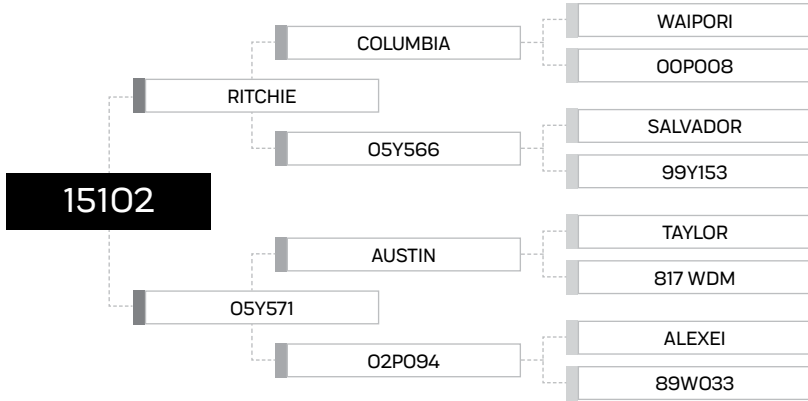

LOT 34

9 Year old Hind



BLACK FOREST PARK
EUROPEAN RED DEER

COMMENTS

Attila over the Dam of our Stud Sire Harmon and Lot 8 in our 2020 Sale which sold for \$37k. She is incalf to Ferdinand.

V.I.C. Ferdinand

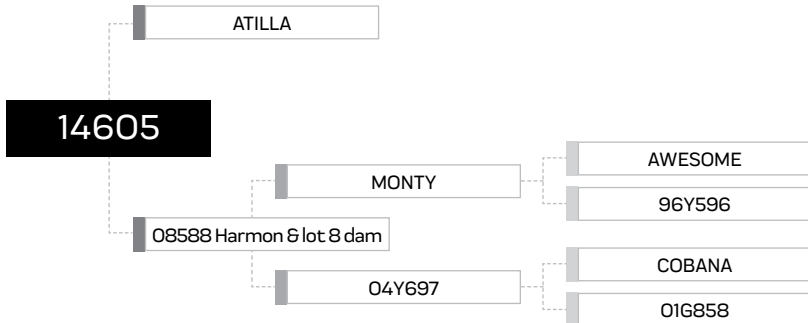

LOT 35

ALONSO SEMEN

Quantity of 5 Straws from our record breaking Sire Alonso, price per straw.



Alonso SCI world record 1164 2/8

LOT 36

KRAKEN SEMEN

Exclusive offering of 2 Straws from Kraken. Semen from this very special Stag is very limited, price per straw.



LOT 37

STARKEY SEMEN

10 Straws of Starkey Semen, price per straw.



LOT 38

STARR SEMEN

10 Straws of Starr Semen, price per straw.



LOT 39

RIISING 3 VELVET STAGS

Tag	Sire	Dam	Dam Sire	2 year Velvet (kg)	Grade
21004	18187	18559	ABACUS	3	As
21040	18187	18360	JOSEPH	2.8	As
21042	10933	11424	SANCHO	2.6	As
21079	10933	17315	ORDONO	3	As
21321	18696	19438	ORDONO	3.1	As
21327	18696	19288	DIMITRI	3	As
21329	18696	19178	ABACUS	3.2	As
21412	18187	16411	ORDONO	3	As
21428	18187	18469	JOSEPH	3	AL
21486	MAPLE	13488	WAIPORI	3.2	As

This sale will be hosted by bidr® (www.bidr.co.nz) as a fully online, SEQUENTIAL auction, with the sale being opened at Lot 1 at the specified sale start time, and all bidding occurring online as the sale moves through the catalogue in sequential order.

The closing of bidding on each lot is controlled by the expiry of the countdown timer. All intending purchasers must register on bidr® in advance of the sale date, by visiting the website and using the "sign up" button, adding their contact information and nominating the agency they would like to purchase through an account held with that agency.

The bidr® team is contactable on 0800 TO BIDR (0800 86 2437), or email enquiries@bidr.co.nz for assistance at any point.

Alternatively, contact your local bidr® representative:

Caitlin Barnett

Sales and Operations Manager
027 405 6156

Bruno Santos

Upper North Island Territory Manager
027 221 8276

Aimee Flynn

Lower North Island Territory Manager
027 282 1710

Mckenzie Alfeld

Upper South Island Territory Manager
027 341 8066

Bianca Perkins

Upper South Island Territory Manager
027 732 0006

Sam Murphy

Lower South Island Territory Manager
027 243 2736

Olivia Manley

Sales Coordinator
027 348 6354



BLACK FOREST PARK

EUROPEAN RED DEER

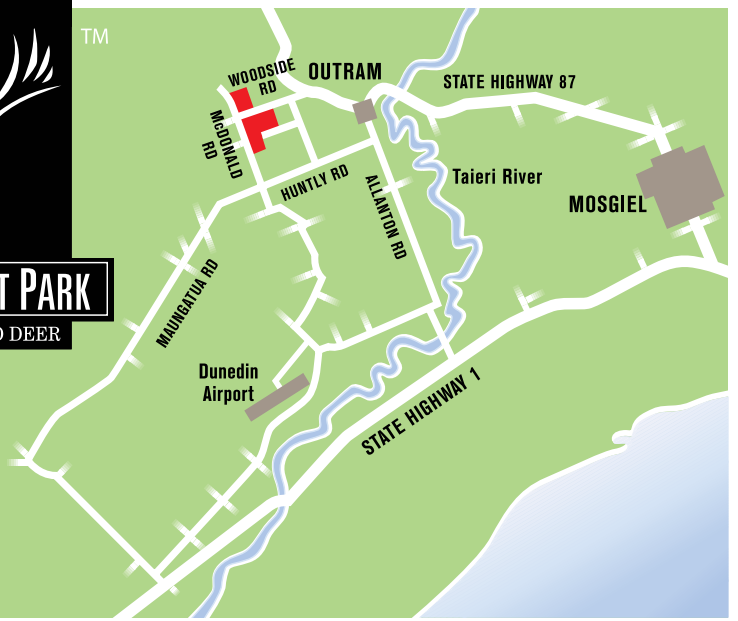

BLACK FOREST PARK

POSTAL: 166 Blaikie Road,
RD2, Clinton 9584

CONTACT: Richard Currie
Mobile 027 276 0664
email richard@blackforest.co.nz

Luke Thompson 027 308 3426
(PGG Wrightson - Canterbury)

Murray Coutts 027 403 9377
(PGG Wrightson South and Mid Canterbury)

John Williams 027 241 4179
(PGG Wrightson - Otago)

Ben Beadle 027 728 1052
(PGG Wrightson - Southland)

DEER AGENTS

SOUTH ISLAND

Adam Whaanga 027 418 3438
(Rural Livestock Ltd)

Craig North 027 473 0864
(Rural Livestock Ltd)

Graham Kinsman 027 422 3154

NORTH ISLAND

Steve Annan 027 215 6671
(PGG Wrightson)

Paul Lampp 027 442 6477

Keith Burden 027 597 5801
(Hawkes Bay)

or your Deer Agent

 blackforest.nz

 [/blackforest.nz](https://www.facebook.com/blackforest.nz)